

OWNER'S MANUAL

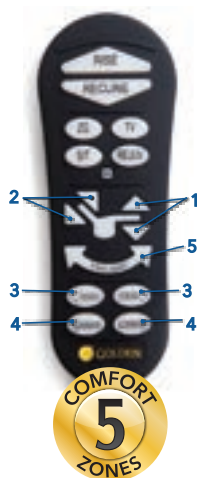

Comfort Zone[™]
by GOLDEN

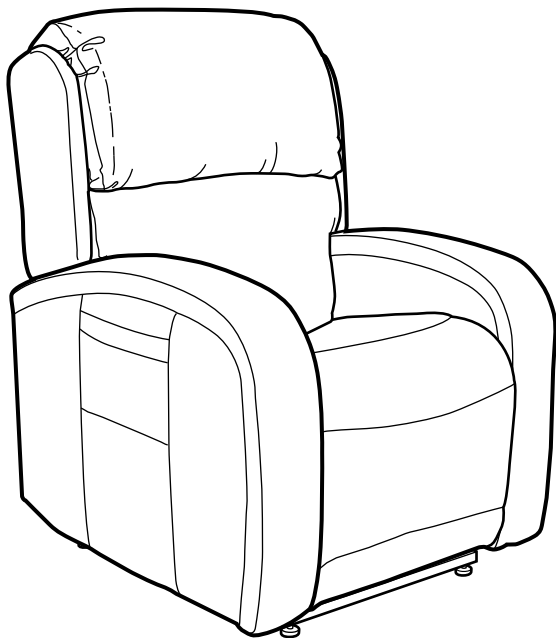

WE PATENTED COMFORT[™]



Golden Technologies • 401 Bridge Street • Old Forge, PA 18518
Tel: 800-624-6374 • Fax: 800-628-5165 • www.goldentech.com

Intended Use: The intended use of this device is to serve as an electric positioning chair with motorized positioning controls intended for medical purposes. The device may be used in environments such as hospitals and nursing homes, as well as residential homes. The device is used to provide patients with additional stability when rising from a seated position as well as alter postural positions. Individuals suffering from involuntary spasm conditions, such as athetosis, may benefit from the various positions offered by the device when attempting to stand from a seated position.

TABLE OF CONTENTS

I. INTRODUCTION.....	3
II. SAFETY.....	4
III. YOUR CHAIR	9
IV. INSTALLATION	10
V. OPERATION	15
VI. COMPARTMENTS AND FEATURES.....	21
VII. CARE AND MAINTENANCE.....	22
VIII. EMI/RFI	23
IX. QUESTIONS AND ANSWERS.....	26
X. BASIC TROUBLESHOOTING.....	27
PRODUCT REGISTRATION.....	29

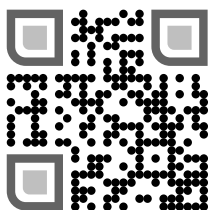

Scan with your smartphone camera or visit www.goldentech.com/manuals to view or download this document in other languages.

I. INTRODUCTION

Dear Valued Customer,

Thank you for purchasing this Golden Technologies recliner. As a family-owned and operated company, we are proud to be the leading manufacturer of power lift recliners in the furniture industry. Our hope is that with this recliner, you will not only have a favorite seat in the house, but that you will also gain a new level of comfort with our patented wellness positioning and lift options.

We take great pride in building a quality product with innovative designs and features to support your lifestyle. Please take a few moments to read through this manual and become familiar with the operation of this recliner and the warranties that support it. To learn more about your recliner and other Golden Technologies products, visit our website at www.goldentech.com.

Also, please note the following safety information: This power lift recliner is a motor operated appliance approved for household and commercial use designed to help you sit down and stand up. Do not allow children to operate the chair at any time.

Thanks again for choosing Golden Technologies.



Sincerely,

A handwritten signature in black ink that reads "Richard Golden". The signature is fluid and cursive, with a long horizontal stroke at the end.

Richard Golden
Chief Executive
Officer



Complies with
UL 73 and
CSA C22.2 No. 68

II. SAFETY

Safety Guidelines

The symbols below are used in the owner's manual and/or on the product to identify warnings and notify you of important safety information. Make sure you read and understand them completely.



WARNING! Indicate(s) a hazardous situation which, if not avoided, could result in death or serious injury. This icon is represented as a black symbol on a yellow triangle with a black border.



MANDATORY! Failure to perform mandatory actions could cause personal injury and/or equipment damage. This icon is represented as a white symbol on a blue dot with a white border.



PROHIBITED! Indicate(s) an action(s) that should not be performed under any circumstance. Failure to adhere could cause personal injury and/or equipment damage. This icon is represented as a black symbol with a red circle and red slash.

Safety Symbols

The symbols below identify warnings, mandatory actions, and prohibited actions. They can be found in the owner's manual and/or on the product. Make sure you understand all safety labels before operating the product. **Do not** remove safety labels from your product.



Read and follow owner's manual!



Child and/or Pet Crush Hazard!



Pinch/Crush Point Hazard!



Transformer Crush Hazard!



Adult, Child and/or Pet Tip Over Hazard!



Fire Hazard!



II. SAFETY

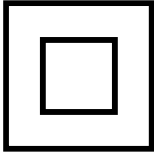

**Class II electrical equipment
according to IEC 61140**

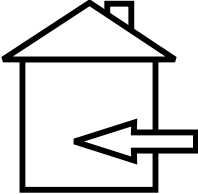

Indoor use only!



Do Not Smoke!



Electrical hazard!



Do not dispose in trash!



Batteries required!

II. SAFETY MANDATORY



READ THIS MANUAL FIRST BEFORE INSTALLING OR OPERATING YOUR POWER LIFT AND RECLINE CHAIR.

Your power lift and recline chair has been engineered from the leg levelers up to provide the ultimate in strength and reliability. Great care has been taken to provide you with total comfort and safety. Golden Technologies thoroughly inspects and tests each unit prior to shipment.

WARNING



Your Golden power lift chair is a medical device. Therefore, you are required to exercise caution when operating it to ensure your personal safety and that of others around you. The following are rules for the safe operation of your Golden power lift chair.



Care should be taken in the unpacking of this unit, so as not to cause injury to persons or damage to the unit. Dispose of all plastic bags and covers, as they can be a smothering hazard to small children.



To operate this chair properly, you must read and understand the intended use of the product, and overall operation of the chair as misuse, or lack of proper training may lead to serious injury.



Do not allow children or pets near the chair while the chair is operating.



Do not allow children to play with or operate the chair at any time.



Hand control should be unplugged and placed out of the reach of children when the chair is not in use.



Do not flop down into the chair when getting into it, or while it is in its lift position. Flopping down into the chair will damage it and could cause personal injury.



Do not allow anyone to sit on your lap, or on the arm of the chair, or on the footrest while in or operating the chair, as it may cause tipping and could result in personal injury.



Do not place fingers or hands between the seat cushion and the inside arm of the chair while sitting in the chair or when the chair is in operation or plugged into a power source.



Do not retrieve fallen objects from inside or under the chair while the chair is plugged into a power source.



On some models, the hand control is routed between the seat and back to easily adapt to left- or right-hand use. Use extreme care before operating your device to ensure electrical cables are not located near pinch points, such as in between the seat and arms near the recline mechanism.

II. SAFETY



Do not operate the chair if there are any persons, pets or other obstructions under or in front of the footrest, under the chair or behind the chair.



Do not position yourself, child and/or pet too high on the chair while the chair back is reclined. This can cause a tip over hazard. Make sure you are properly fitted for the lift chair prior to operating the chair.



Do not smoke while operating, sitting or resting in the chair.



To reduce risk of electrical shock, do not immerse any of the electrical components into a liquid, or spill any liquids onto electrical components. Do not open any of the electrical components. There are no serviceable parts.



Warranty will be void if any of the electrical components are opened by other than a qualified service person.



Make sure the chair is placed at the specified distance from a wall/corner (page 11). Failure to do so can damage the chair and will void the warranty.



Do not use any type of electrical extension cord to plug your chair into an electrical outlet. Make sure that all electrical products and their wires are positioned away from your chair as the metal lift frame mechanism could crush them and create a fire hazard and/or may cause personal injury.



Do not operate your lift chair while intoxicated or taking medications that impair your mental or physical abilities to operate the chair safely. Consult with your doctor about any medications you are taking that may affect the safe operation of the chair.



Do not operate this product if you have any medical conditions that result in limited, debilitating mental or physical capacity. You should consult your doctor before using this product.



Consult with your physician regarding using the Trendelenburg position.



Placing the lift chair in the center of a room or too far away from a wall will create a tripping hazard, because the power wires for the lift chair will be crossing main traffic areas in the residence.



Leakage from the 9VDC backup batteries can result in property damage. Periodically inspect and replace the batteries. Read the "Battery Back Up System" and "Care and Maintenance" sections in this manual.



The mechanical components of this base utilize mechanisms that, when in operation, can cause pinching and lacerations at certain points of contact. These points are referred to as Pinch Points and are identified with symbol to the left. Keep clear of pinch points.

II. SAFETY



If the lift chair user is unconscious or sleeping the hand control may inadvertently become activated in a way that may force the user out of the chair.



Should you ever encounter a problem with the operation of your power lift chair, discontinue all use of the product upon discovery of the problem. Contact the retailer from whom you purchased your chair to arrange service.



Exceeding the weight limit can result in instability of the lift chair, causing a potential tip over hazard. The weight limit is displayed on a label located on the rear of the lift frame next to the serial number.



Consult the owner's manual of the chair and a physician to determine if you are capable of moving or lifting the chair, as this will cause serious injury if not done properly.



Verify that all objects including hands and fingers are not between the arm of the chair and the open compartment before closing the compartment as this will result in property damage or serious injury.



This is an electrical device and will be impacted by any power failure.



Use extreme care when unpacking, assembling, and disassembling of this unit, so as not to cause injury to persons or damage to the unit.



Use of accessories, transducers and cables other than those specified or provided by the manufacturer of this equipment could result in increased electromagnetic emissions or decreased electromagnetic immunity of this equipment and result in improper operation.



Portable RF communications equipment (including peripherals such as antenna cables and external antennas) should be used no closer than 30 cm (12 inches) to any part of the device, including cables specified by the manufacturer. Otherwise, degradation of the performance of this equipment could result.

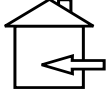

This device is intended for indoor use only.



If this product, as supplied, becomes a waste in the United States, it may meet the criteria of a hazardous waste as defined under RCRA, Title 40 CFR 261. It is the responsibility of the waste generator to determine the proper waste identification and disposal method. For disposal of unused or waste material, check with local, state and federal environmental agencies.



This product contains chemicals known to the State of California to cause cancer and birth defects or other reproductive harm.

III. YOUR CHAIR

CHAIR COMPONENTS

Chairs are equipped with a metal frame, wooden frame, and electrical components. These components vary by model, and electrical components function differently in various models. Please refer to figure 1 below as a reference only.

HAND CONTROL:

Operates the chair via buttons manually pressed by the operator. For specific functions, refer to the "OPERATION" section in this manual.

QUICK-RELEASE:

Allows the user to remove the hand control from the chair.

UPHOLSTERED COMPONENTS:

1. Removable back
2. Arm
3. Seat
4. Chaise pad
5. Footrest

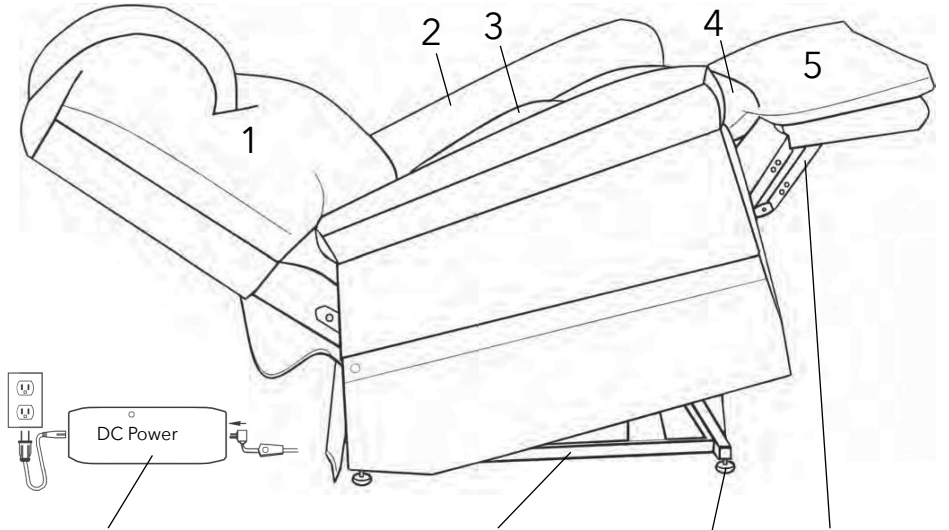

EXTERNAL POWER SOURCE:

Transformer, power cord, and motor/transformer cable. Allows the chair to function by supplying 29V DC to the control box, motors, and hand control.

LIFT MECHANISM, RECLINE MECHANISM AND CHAIR FRAME:

⚠ WARNING: PINCH POINT
Allows the chair to achieve all positions, by mechanical movements.

SCISSOR MECHANISM:

⚠ WARNING: PINCH POINT
Extends/retracts during the various lift/recline positions.

LEG LEVELERS: (MANUAL ADJUSTMENT)

Can be adjusted up/down to stabilize the chair on uneven surfaces, and different carpet naps.

Figure 1. Chair Components

IV. INSTALLATION

There are three external power source scenarios depending on the model of your chair.

1. Transformer without battery back up. (Note: An uninterruptible power supply or UPS, may be purchased from an outside source as a battery backup).
2. Transformer with battery back up using two 9 volt batteries. **Batteries not included.**
3. Transformer with a rechargeable lithium battery pack.

(Note: For additional information, see the instructions that came with the transformer/rechargeable lithium battery backup.

Transformer without battery backup

1. Remove AC/DC adapter (transformer) from packaging located under base of chair. Place transformer on floor behind the chair. Proceed to step 2.

Transformer with battery backup

1. Remove AC/DC adapter (transformer) from packaging located under base of chair. Place two 9 volt alkaline batteries (not included) into the slots provided as shown. Place transformer on floor behind the chair. Proceed to step 2.

⚠ WARNING: Once used, batteries must be replaced. Batteries should also be replaced every year even if they have not been used. Do not mix old and new batteries. Do not mix alkaline, standard (Carbon-zinc), or rechargeable (Ni-Cd, Ni-Mh, etc) batteries. Keep the telephone or some means of communicating with someone within reach.

Transformer with rechargeable lithium battery backup

1. Remove AC/DC adapter (transformer) and lithium battery pack from packaging located under base of chair. Connect the lithium battery pack to the transformer, by sliding them together. Place transformer/lithium pack on floor behind the chair.
2. Locate the power cord from the motor. It is attached to the motor shaft under the chair with a white zip tie. Remove white zip tie, extend the cable under and out behind the chair and connect to the transformer as shown below.
3. Make sure all connections are tight. Plug the adapter wire into a standard (115-120V.A.C.) wall outlet.

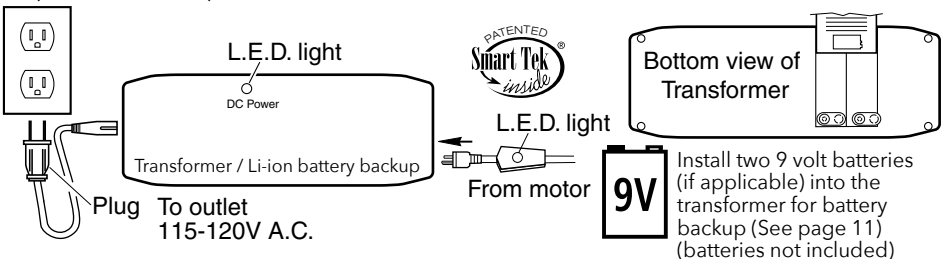

Note: Depending on your chair model it may have an additional battery back up as shown to the right.

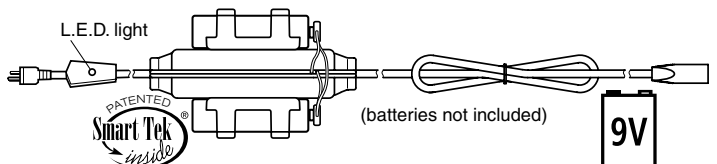

IV. INSTALLATION

CHAIR LOCATION

4. Place your chair in the room where it will be most convenient for you, such as near the television, radio, reading light, end table, or other furniture. Leave enough space between back of chair and wall or other obstruction to allow the chair to recline unobstructed.

Note: The distance required is approximately 18 inches for 1-zone models, and approximately 25 inches for 2, 4, and 5-zone models. Recline space needed may vary based on chair model.

 **WARNING: Do not allow any objects to restrict movement of the back of chair or the footrest, which can result in damage to the chair and/or property damage.**

Some carpets have a high plush pile that can rub on the bottom of the footrest. This situation can damage the mechanism. You can correct this situation by turning the levelers (located under the front of the chair) to raise the footrest enough to clear the carpet.

5. While standing next to your chair, fully recline the chair to make sure the back of the chair and footrest do not come in contact with an obstruction. Once you have completed this test run, you are ready to use your lift chair.

Battery Backup Systems

Your Golden power lift chair may come with a battery back up system depending on the model, so the chair can return to the seated position in the event of a household power failure.

Models with 9 volt batteries have enough energy to bring the chair to a seated position from the recline position. The batteries do not have enough energy nor are they intended to operate the chair for a prolonged period of time in the absence of standard household voltage (120 volt, 60 Hz). Batteries should be replaced after one use. Batteries should be changed yearly. (See installation page 10.)

Models with the lithium battery pack have enough energy to bring the chair to a seated position from the recline position. The lithium battery pack is not intended to operate the chair for a prolonged period of time in the absence of standard household voltage (120 volt, 60 Hz). However, the lithium battery pack will self charge as long as the chair is plugged in and household voltage is present. Batteries should be fully charged and disconnected from the lift chair if the chair will not be used for extended periods of time.

IV. INSTALLATION

SmartTek™ (Power Indication)

Your power lift chair is equipped with either a backlit hand control or a LED light on the hand control indicating power to the hand control.

Your power lift chair also comes with a power indicator (LED light) on the transformer and on the power cord connecting the motor to the transformer. The lights illuminate green constantly, indicating power from the outlet to the transformer and the motor. The lights have been provided to help you identify electrical disconnects, should they occur, and to help your retailer to diagnose electrical problems, should they occur.

Should the chair not operate and the lights are out, check all electrical connections to the chair. Make sure everything is plugged in properly and there is power to the outlet into which the chair is plugged (see installation on page 10 for electrical connections). **Should you ever encounter a problem with the operation of your power lift chair and the lights are on, such as mechanical problems or one light is out, discontinue all use of the product upon discovery of the problem.** Contact the retailer from whom you purchased your chair. They will be able to resolve problems and take care of proper factory service if needed. You will need to be prepared to answer some basic questions about your power lift chair, such as model and serial number. The model and serial number are located on the hand control cord, on the cover of this manual, and on the rear of the lift frame. Your retailer will ask you questions about your power indicator lights, such as which one is out. Prior to calling your retailer, check all the electrical connections to the chair. Make sure everything is plugged in properly and there is power to the outlet into which the chair is plugged (see installation on page 10 for electrical connections).



IV. INSTALLATION

Back Installation

Your chair may come with the back installed or may need to be installed depending on the model of chair. There are three types of back installation: bolt (without back motor), bolt (with back motor) & bracket. If your chair requires back installation, refer to the proper instructions below.

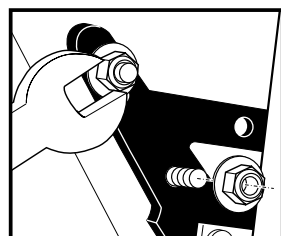
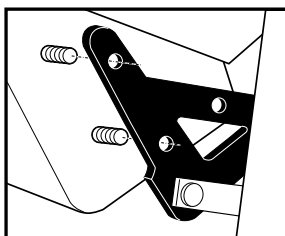
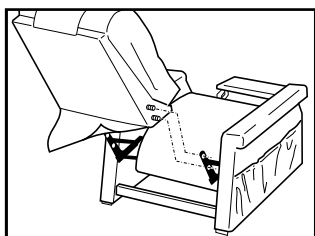

Bolt Installation - Without Back Motor

1. Operate the hand control until the footrest is about parallel to the floor. This will expose the back brackets at the rear of the chair.
2. Slide the back down between the brackets until the threaded studs on the back slip through the holes in the brackets as shown.
3. Thread the flange lock nuts onto the studs and tighten securely using the supplied wrench or a 7/16" box wrench. Return the chair to the seated upright position by operating the hand control.
4. Attach the bottom of the outside back to the Velcro on the arm cross rail.

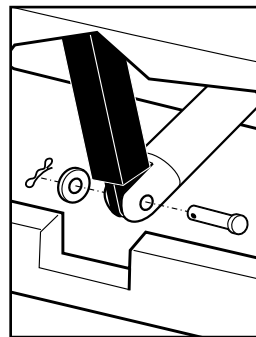
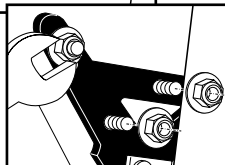
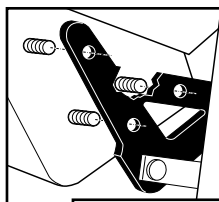
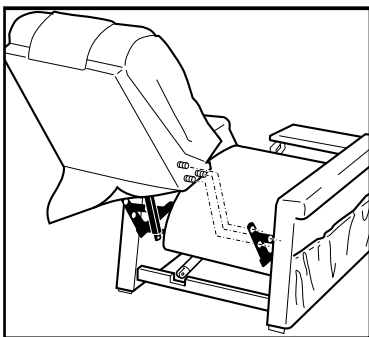

Bolt Installation - With Back Motor

1. Operate the hand control until the footrest is about parallel to the floor. This will expose the back brackets at the rear of the chair.
2. Slide the back down between the brackets until the threaded studs on the back slip through the holes in the brackets as shown.
3. Thread the flange lock nuts onto the studs and tighten securely using the supplied wrench or a 7/16" box wrench.
4. Remove the clevis pin from the back recline motor tip. Slide the motor tip onto the back recline bar. Insert clevis pin through the hole in the tip and bar. Insert hair pin into the hole at the end of the clevis pin as shown.
5. Return the chair to the seated upright position by operating the hand control.
6. Attach the bottom of the outside back to the Velcro on the arm cross rail.

IV. INSTALLATION

Back Installation - continued

Bracket Installation

To install seat back:

1. Align both brackets, located on opposite sides of the seat back under the fabric and the seat.
2. Push the seat back down to lock it into place. Note: An audible click will be heard indicating the brackets are locked.
3. Attach the bottom of outside back to the Velcro on the arm cross rail.

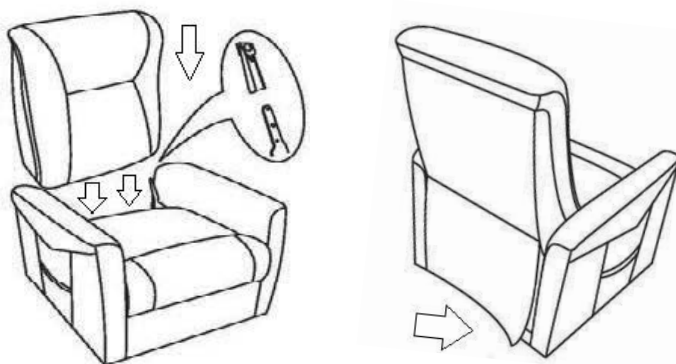

To remove seat back:

1. Lift the fabric away from the Velcro on the cross rail.
2. Lift the tab on both brackets, located on opposite sides of the seat back under the fabric.
3. Lift the seat back up and off the seat of the chair.

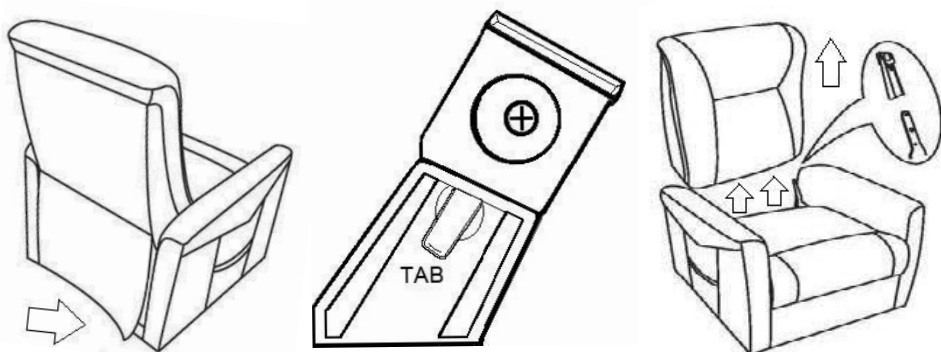

V. OPERATION:

Your hand control operates all the movements of your chair. Match your hand control to one of the hand controls listed in this section of the manual and follow the instructions to operate your chair.

V. OPERATION: 2 Button

Will lower you to a seated position from raised or a reclined position from seated.

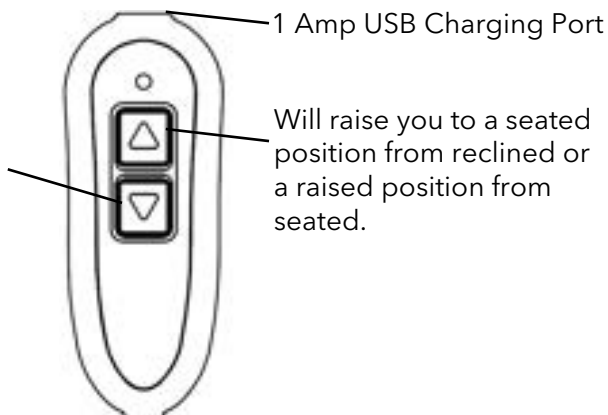



1. **Getting into your lift chair.** While standing next to your chair, press the chair up button (▲) and raise the chair to a height you can sit against. This height will vary from person to person depending on the individual's needs. Raise the chair high enough so you do not have to flop down into the chair. **Flopping down into the chair may damage it and could cause personal injury.** Press the chair down button (▼). As the chair continues downward, adjust yourself into a position that is comfortable to you. Continue pressing the button until chair is in the seated position (chair firmly on the floor), then release the button.
2. **Getting out of your chair.** Press the chair up button (▲) and raise the chair to a height that enables you to easily stand. Release the button. Return the chair to the seated position (chair firmly on the floor) after getting out of the chair so children, pets or obstructions do not get under the chair.

USB Disclaimer: The supplied USB charging port is only intended to be used with appropriate devices. Please refer to device manufacturer's charging requirements before using as some device may not be compatible. Golden Technologies excludes liability for any damages or data loss regarding the charging device on a computer or other electronic device connected to the USB port.

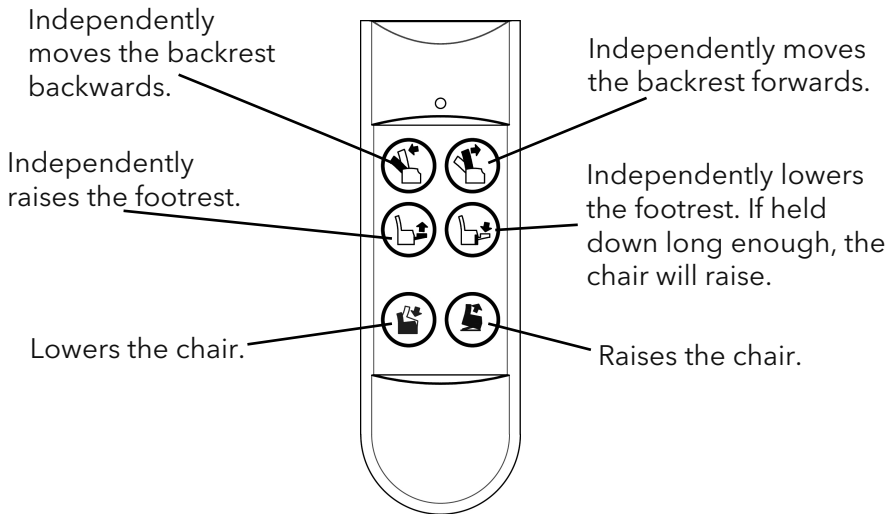
V. OPERATION: 6 Button



- 1. Getting into your lift chair.** While standing next to your chair, press button () and raise the chair to a height you can sit against. This height will vary from person to person depending on the individual's needs. Raise the chair high enough so you do not have to flop down into the chair. **Flopping down into the chair may damage it and could cause personal injury.** Press button (). As the chair continues downward, adjust yourself into a position that is comfortable to you. Continue holding button until chair is in the seated position (chair firmly on the floor), then release the button. Continue operating the chair with the independent buttons until you reach your desired position.
- 2. Getting out of your chair.** Press button () and raise the chair to a height that enables you to easily stand. Release the button. Return the chair to the seated position (chair firmly on the floor) after getting out of the chair so children, pets or obstructions do not get under the chair.

Note: The motors are set to shut off when they reach their fully extended or fully retracted position if the selected button is not released. If you should go past your desired position, select the button to bring you back to your desired position. You can repeat the process as often as you like.

V. OPERATION:

This section will cover the following hand controls.

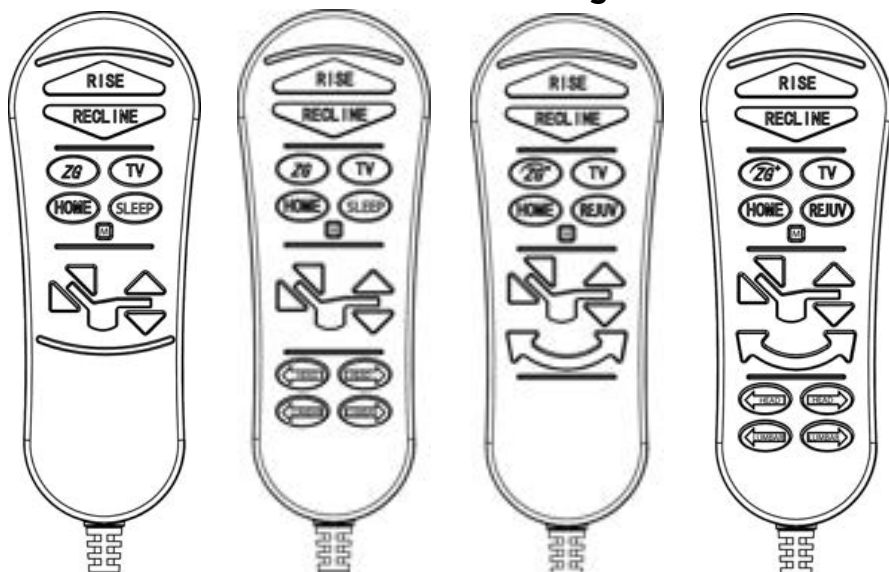

- 1. Getting into your lift chair.** While standing next to your chair, press button **(RISE)** and raise the chair to a height you can sit against. Raise the chair high enough so you do not have to flop down into the chair. **Flopping down into the chair may damage it and could cause personal injury.** Press button **(HOME)**. As the chair continues downward, adjust yourself into a position that is comfortable to you. Continue holding button **(HOME)** until chair is in the seated position (chair firmly on the floor), then release the button. You can also press buttons **(ZG or ZG+,TV, SLEEP or REJUV)** and the chair will move to those positions.
- 2. Getting out of your chair.** Press button **(RISE)** and raise the chair to a height that enables you to easily stand. Release the button. Return the chair to the seated position **(HOME)** (chair firmly on the floor) after getting out of the chair, so children, pets or obstructions do not get under the chair. Repeat no. 1 when you want to sit down.

Micro Adjustments

The following buttons will allow you to move the back and footrest independently.

Will move the Backrest up.

Will move the Backrest down.

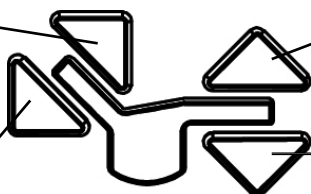

Will move the Footrest and seat up.

Will move the footrest and seat down. **NOTE: If held down long enough, this will operate the same as RISE.**

V. OPERATION:

Tilting Adjustments

If your chair is equipped with a cradle, you will be able to tilt the chair with the following buttons.

Will tilt the chair forward.



Will tilt the chair backward.

Headrest and Lumbar Adjustments

If your chair is equipped with headrest and lumbar capabilities, you can adjust them with the following buttons.

Will move the Headrest backward.



Will move the Headrest forward.

Will move the Lumbar backward.



Will move the Lumbar forward.

Calibration

You must perform the following calibration procedure before operation. The control system relies on sensors and memory to function properly. Performing this procedure will ensure proper operation of your chair.

While standing beside your chair. Press and hold all two or three (if equipped with a cradle) highlighted buttons simultaneously until the chair stops moving. Continue to hold all buttons simultaneously for an additional three seconds.



NOTE: Calibration cannot be performed on chairs that don't have control boxes.

When Calibration is complete your chair should look like this. Once complete you may operate your chair.



- From time to time, the control system may need to be re calibrated.
- This may be due to normal circumstances such as disconnecting power abruptly, power surges, or electrical outages.
- If the movement of the chair does not feel correct, recalibrating the system may resolve the issue.

V. OPERATION:

Preprogrammed Memory Positions

NOTE: If your chair is equipped with a cradle you will have ZG+ and REJUV. If your chair is not equipped with a cradle you will have ZG and SLEEP.



ZG - Zero Gravity offers a supportive feeling of weightlessness.

ZG+-Zero Gravity + offers a supportive feeling of weightlessness combined with the tilting motion of the cradle.

HOME - Provides an easy and stress-free way to return your chair to the proper seated position.

TV - Takes you to the perfect position to relax while watching TV.

REJUV- Allows you to elevate your feet and legs comfortably for a long period of time.

SLEEP - Takes your body to a traditional lay flat position, which can be comfortable for napping during the day or sleeping at night.

Programming Memory Positions

NOTE: All preprogrammed memory buttons can be reprogrammed except HOME.

NOTE: Headrest and Lumbar adjustments are not programmable.

If you find a position that you find more suitable than the preprogrammed positions, you can save that position over one of the preprogrammed buttons as follow:

1. Using any adjustment features to put your chair in the position you want to save.
2. Hold the **M** button until the hand control back light starts to flash.
3. Press any of the preprogrammed buttons you want to save that position to.

Factory Reset

Resets all the programmed buttons back to the factory settings.

1. Hold the **M** button until the hand control back light starts to flash.
2. Press the buttons in sequential order as shown in the photo to the right.



V. OPERATION:

Hand Control Disable

Disables all functions on the hand control.

1. Hold the **M** button until the hand control back light starts to flash.
2. Press the buttons in sequential order as shown in the photo to the right.
3. To enable functions again repeat this process.

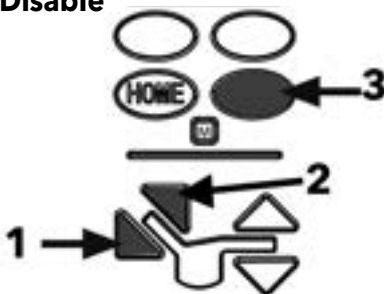

Function Lock

Disables all functions on the hand control except for **RISE** and **RECLINE**.

1. Hold the **M** button until the hand control back light starts to flash.
2. Press the buttons in sequential order as shown in the photo to the right.
3. To unlock and enable all other functions again repeat this process.

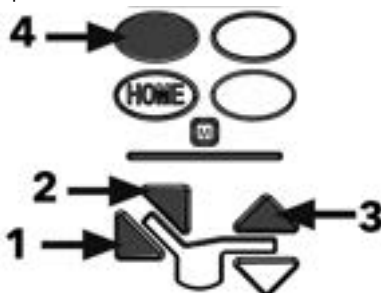

Lights Out Feature

This feature will automatically shut off the back light on the hand control after a specified period of inactivity (approximately 15 seconds).

1. Hold the **M** button until the hand control back light starts to flash.
2. Press the buttons in sequential order as shown in the photo to the right.
3. To deactivate repeat this process.

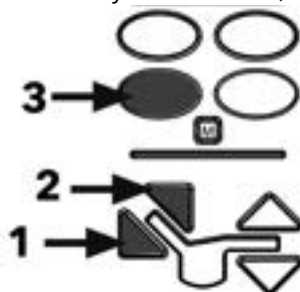

VI. COMPARTMENTS AND FEATURES

Your chair may be equipped with some of the following compartments and features.

Storage Compartment

USB Port

Storage Compartment

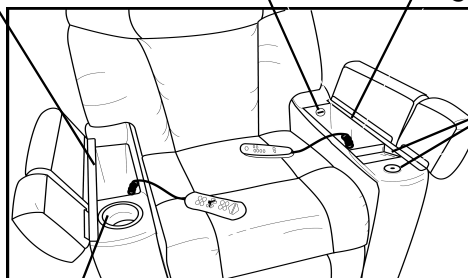

Some chairs may have a Wireless Charger and Device Mount or a Cup Holder

Cup Holder

Device Mount

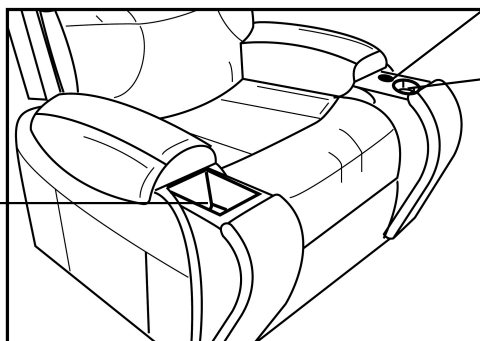

Wireless Phone Charger

Cup Holder

Storage Compartments - Allows for convenient storage and easy access of your remote controls, various personal items, and various accessories used with the Device Mount.

USB Port - Allows you to use and/or charge most electronic devices. Output of 2A.

Cup Holders - Allows for convenient access for cups and bottles.

Wireless Charger - Allows you to charge your cell phone by simply laying the device on the charging pad.

Device Mount - This receiver allows you to enhance your chair by adding accessories such as table or a tablet holder.



WARNING Motion of your lift chair will affect the stability of items placed in the cup holder and items used with accessories for the Device Mount. Unstable items could cause property damage or personal injury.

VII. CARE AND MAINTENANCE

Your lift chair will require routine maintenance checks. You can perform some of these checks, while others may require assistance from a retailer. By following these maintenance checks, you can make sure your lift chair gives you years of trouble-free operation. If you have any questions or concerns regarding your lift chair's care and maintenance, visit our website at www.goldentech.com.

- ✓ Before cleaning your lift chair, consult your retailer for the proper types of cleaner and cleaning methods.
- ✓ Keep all electrical components free from moisture and liquid spills. **Intended for indoor use only.**
- ✓ Periodically inspect all wiring harnesses to make sure they are not cut, damaged, frayed, or disconnected. If damage of any type is present, unplug the lift chair and contact your retailer.
- ✓ Periodically check all fasteners for tightness, wear, and corrosion. If any of these are present, unplug the lift chair and contact your retailer.

⚠ Warning: Be careful of pinch points and sharp metal parts (wear gloves).

⚠ Warning: Failure of any critical component on your chair may prevent the chair from returning to a seated position. This may result in not meeting the intended use of the chair. Critical components include Hand Controls, Motors, Transformer, Harnesses and Metalware.

Hand Controls

Lift chairs can have the hand control routed through the pocket or the seat depending on the model.

To access and remove a hand control routed through the pocket, simply reach into the pocket and open the lock on the extension cable.

To access, remove, or re-route a hand control routed through the seat see the instructions below.

Hand Control Inside Arm Routing

To move the hand control from one side to the other, follow the instructions below.

1. Lift the bottom of outside back from the Velcro on the arm cross rail.
2. Remove the hand control wire from the J-Clip.
3. Unlock the extension wire, and separate. **Note: This step disables all lift chair functions.**
4. Route the hand control wire through the opposite J-Clip.
5. Reconnect the extension wire, and lock to secure.

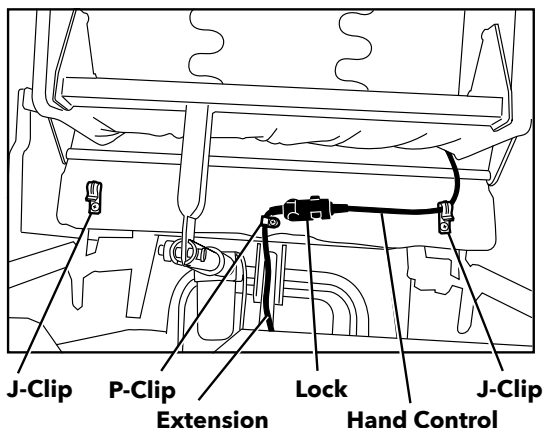

VIII. EMI/RFI

The rapid development of electronics, especially in the area of communications, has saturated our environment with electromagnetic (radio) waves that are emitted by television transmitters, cellular phones, citizen's band radios (CBs) amateur radios (HAM radios), wireless computer links, micro-wave transmitters, paging transmitters, etc. These electromagnetic (EM) waves are invisible and increase in strength the closer one gets to the source of transmission. When these energy waves act upon electrical devices and cause them to malfunction or to function in an erratic or uncontrolled manner, they are referred to as Electromagnetic Interference (EMI) or Radio Frequency Interference (RFI). All electrically devices, including this lift chair are susceptible to EMI/RFI. This interference could result in abnormal operation or unintended movement of your lift chair.

The FDA has determined that each make and model of lift chair can resist EMI/RFI to a certain level. The higher the level of immunity, the greater the degree of protection from EMI/RFI measured in volts per meter (V/m). The FDA has also determined that current technology is capable of providing 10 V/m of immunity to EMI/RFI, which would provide useful protection against common sources of interference. This product has been tested and has passed an immunity level of 10 V/m.

EMI/RFI RECOMMENDATIONS



Do not turn on or use hand-held personal electronic communication devices such as cellular phones, walkie-talkies, or CB radios while your lift chair is in motion.

- Be aware of any nearby transmitters (radio, television, microwave, etc.) and avoid operation your of lift chair close to any of those transmitters.
- Turn off the power if your chair is going to be not in use for any length of time.
- Be aware that adding accessories or components or modifying your lift chair may make it more susceptible to EMI/RFI.
- If unintended movement, turn your lift chair off as soon as it is safe to do so.
- Report all incidents of unintended movement to your Golden Technologies representative or to Golden Technologies.

VIII. EMI/RFI Continued

Emission/Immunity test standard refer to the normative references in IEC 60601-1-2 edition 4.0)	IEC 60601-1-2 Compliance Level		
Conducted and Radiated RF Emission <i>CISPR 11</i>	<i>Group 1 Class B</i>		
Harmonic Distortion <i>IEC 61000-3-2</i>	<i>Class A</i>		
Voltage Fluctuations/Flicker <i>IEC 61000-3-3</i>	<i>N/A</i>		
Electrostatic Discharge (ESD) <i>IEC 61000-4-2</i>	± 8 kV contact ± 2 kV, ± 4 kV, ± 8 kV, ± 15 kV air		
Radiated RF EM Fields <i>IEC 61000-4-3</i>	10 V/m 80 MHz to 2.7 GHz 80% AM at 1 kHz		
Proximity fields from RF wireless communications equipment	<i>Test Frequency (MHz)</i>	<i>Band (MHz)</i>	<i>Immunity Test Level (V/m)</i>
	385	380-390	27
	450	430-470	28
	710	704-787	9
	745		
	780		
	810	800-960	28
	870		
	930		
	1720	1700-1990	28
	1845		
	1970		
	2450	2400-2570	28
5240	5100-5800	9	
5785			
Electrical Fast Transit/Burst <i>IEC 61000-4-4</i>	± 2 kV for power supply lines 100 kHz repetition frequency		
Surge <i>IEC 61000-4-5</i>	± 1 kV (line(s) to line(s))		
Conducted Disturbances induced by RF <i>IEC 61000-4-6</i>	3 V 0.15 MHz - 80 MHz 6 V in ISM bands and amateur radio bands between 0.15 MHz and 80 MHz 80% AM at 1 kHz		
Power Frequency Magnetic Field <i>IEC 61000-4-8</i>	30 A/m 50 Hz and 60 Hz <i>Applies only to ME EQUIPMENT and ME SYSTEMS with magnetically sensitive components or circuitry.</i>		
Voltage Dips, Interruptions and Voltage Variations <i>IEC 61000-4-11</i>	0% UT; 0.5 cycle At 0° , 45° , 90° , 135° , 180° , 225° , 270° and 315° crossing 0% UT; 1 cycle and 70% UT; 25 cycles Single phase: at 0° crossing 0% UT; 250 cycle		

VIII. EMI/RFI Continued

FCC Rules Part 15

This device complies with Part 15 of the FCC Rules. Operation is subject to the following two conditions: (1) this device may not cause harmful interference, and (2) this device must accept any interference received, including interference that may cause undesired operation.



Warning: Any changes or modifications to this unit not expressly approved by the party responsible for compliance could void the user's authority to operate the equipment.

NOTE: This equipment has been tested and found to comply with the limits for a Class B digital device, pursuant to Part 15 of the FCC Rules. These limits are designed to provide reasonable protection against harmful interference in a residential installation. This equipment generates, uses, and can radiate radio frequency energy and, if not installed and used in accordance with the instructions, may cause harmful interference to radio communications. However, there is no guarantee that interference will not occur in a particular installation. If this equipment does cause harmful interference to radio or television reception, which can be determined by turning the equipment off and on, the users encouraged to try to correct the interference by one or more of the following measures: (1) Reorient or relocate the receiving antenna. (2) Increase the separation between the equipment and receiver. (3) Connect the equipment into an outlet on a circuit different from that to which the receiver is connected. (4) Consult the dealer or an experienced radio/TV technician for help.

IX. QUESTIONS AND ANSWERS

Lift Chair FAQs

What is a three-position lift chair?

With a three-position lift chair, when the chair is reclining and the footrest is going up, the backrest reclines back farther, opening the angle between the backrest and the seat. The chair can recline more fully into a “sleeper” or “napper” position.

Some of your chairs have a “split chaise pad” while others are described as having a “full chaise pad.” What is the difference?

A “split chaise pad” means there is a gap between the front edge of the seat and the footrest. The gap is covered with a piece of fabric called an apron.

A “full chaise pad” means there is one continuous piece of seat foam covered in fabric from the very back of the seat all the way through to the front end of the footrest, providing more support and comfort for the legs when the footrest is raised.

My hand control has buttons labeled TV and ZG. What does that mean?

Golden’s unique AutoDrive hand controls for our MaxiComfort Zero-Gravity and Twilight lift chairs feature factory programmed buttons for the TV Watching position and the Zero- Gravity position.

With the TV Watching position, the footrest raises up and the backrest reclines very slightly, so that your back, neck and head are properly aligned to watch TV comfortably.

With the Zero-Gravity position, the chair moves your body into the Zero-Gravity position to help relieve stress throughout your entire body.

The Owner’s Manual says my chair goes into the Trendelenburg position. My doctor recommends this position for me to help improve the circulation in my legs. How do I get to the Trendelenburg position?

Golden’s patented MaxiComfort chairs move into the Trendelenburg position. It is very easy to get to. First, raise the footrest all the way up. Then recline the back all the way down. The chair is now in the Trendelenburg position.

How can I find a retailer in my area who sells Golden products?

That’s easy! Simply visit our website at www.goldentech.com. You can search for retailers using a specific zip code, by city and state, or by a name search, if you know the company name but aren’t sure where they are located.

X. BASIC TROUBLESHOOTING

Problem	Possible Cause	Solution
Lift chair does not function at all.	Transformer not plugged into wall.	<ul style="list-style-type: none"> • Check that all wire(s) are fully connected. • Reconnect wire(s) if needed.
	Wire(s) from transformer to lift chair unplugged.	
	Wall outlet does not have power.	<ul style="list-style-type: none"> • Check if wall outlet is controlled by a light switch. • Check the associated circuit breaker in your home and reset if necessary.
	Transformer is defective.	<ul style="list-style-type: none"> • Check to see if the transformer LED is illuminated. • If not, test in another outlet. • If still not illuminated, contact retailer for replacement.
	Hand Control Disable feature turned on.	<ul style="list-style-type: none"> • Refer to the OPERATION section of this manual for instructions on enabling the hand control.
Lift chair partially functions.	Hand control damaged.	<ul style="list-style-type: none"> • Visually check hand control for physical damage. • Contact retailer for replacement if necessary.
	Wire(s) disconnected.	<ul style="list-style-type: none"> • Check if all motor and control box cables are connected properly. • Reconnect if necessary.
	System out of calibration.	<ul style="list-style-type: none"> • Perform calibration on hand control as stated in manual.
	Hand control or control box is defective.	<ul style="list-style-type: none"> • Contact retailer for replacement.
	Function Lock feature turned on.	<ul style="list-style-type: none"> • Refer to the OPERATION section of this manual for instructions on unlocking functions of the hand control.
Programmed position incorrect.	System memory compromised.	<ul style="list-style-type: none"> • Perform factory reset on hand control as stated in manual. • Operate chair to desired position and save as stated in manual.
	Hand control defective.	<ul style="list-style-type: none"> • Contact retailer for replacement.

X. BASIC TROUBLESHOOTING

Problem	Possible Cause	Solution
Hand control buttons do not illuminate.	Hand control damaged.	<ul style="list-style-type: none"> • Visually check hand control for physical damage. • Contact retailer for replacement if necessary.
	Hand control defective.	<ul style="list-style-type: none"> • Contact retailer for replacement.
	Lights Out feature turned on.	<ul style="list-style-type: none"> • Refer to the OPERATION section of this manual for instructions to turn off.
Lift chair stops while lifting.	Power failure or surge.	<ul style="list-style-type: none"> • Check the associated circuit breaker in your home and reset if necessary.
	System out of calibration.	<ul style="list-style-type: none"> • Perform calibration on hand control as stated in manual.
	Wire(s) disconnected during lift.	<ul style="list-style-type: none"> • Check that all wire(s) are fully connected. • Reconnect wire(s) if needed. • Verify wire(s) are routed to prevent getting pinched or pulled during operation.
	Battery backup out of energy.	<ul style="list-style-type: none"> • Connect the battery backup to a wall outlet with power. • Refer to the battery backup section of the manual for details.
	Hand control or control box is defective.	<ul style="list-style-type: none"> • Contact retailer for replacement.
Heat and Massage not functioning properly (if equipped)	Wire(s) from main power to junction box is disconnected.	<ul style="list-style-type: none"> • Check that all wire(s) are fully connected. • Reconnect wire(s) if needed.
	Wire(s) from junction box is disconnected.	<ul style="list-style-type: none"> • Check that all wire(s) are fully connected. • Reconnect wire(s) if needed.
	Heat and massage hand control damaged.	<ul style="list-style-type: none"> • Visually check hand control for physical damage. • Contact retailer for replacement if necessary.
	Heat and massage hand control defective	<ul style="list-style-type: none"> • Contact retailer for replacement.
Lift chair is rocking (not stationary) after being positioned in a room.	Floor may be uneven.	<ul style="list-style-type: none"> • Adjust the four leg levelers under the lift chair frame to stabilize the chair.
	There is an obstruction under the lift chair.	<ul style="list-style-type: none"> • Remove all obstructions from under the lift chair.
	Chair may have been damaged in transit or during use	<ul style="list-style-type: none"> • Contact retailer for replacement.



PRODUCT REGISTRATION



Cut along dotted line and **mail to:**

Golden Technologies, 401 Bridge Street, Old Forge, PA 18518

CUSTOMER INFORMATION

FIRST NAME

LAST NAME

ADDRESS

ADDRESS 2

CITY

STATE

ZIP

EMAIL ADDRESS

RETAILER INFORMATION

RETAILER NAME

RETAILER ADDRESS

ADDRESS 2

CITY

STATE

ZIP

PRODUCT INFORMATION

PRODUCT MODEL NUMBER

Numbers and letters beginning with PR and separated by dashes

WHAT DO YOU LIKE MOST ABOUT YOUR NEW RECLINER?

PRODUCT SERIAL NUMBER

Located on the hand control wire, on the metal frame and in this manual

PURCHASE DATE

SAVE TIME!

Register your product online.
Visit goldentech.com
or scan this QR code!



LIKE US ON FACEBOOK!

[Facebook.com/
Golden Technologies](https://www.facebook.com/GoldenTechnologies)

www.goldentech.com

INTENTIONALLY LEFT BLANK

NOTES

FOR YOUR RECORDS

Please fill in your Power Lift & Recline Chair information below. This information will be useful in the event that you should ever need to contact Golden Technologies, Inc. concerning your lift chair.

Date of Purchase _____

Model _____



Serial Number _____

Your Golden Technologies, Inc. representative or retailer

Name _____

Company _____

Address _____

 WARNING 
Do not allow children to play on this mechanized furniture or operate the mechanism.
Leg rest folds down on closing so that a child could possibly be injured.
Always leave chair in a sitting position. Keep hands and feet clear of mechanism. Only the occupant should operate it.

